



Hydraulic Presses Minting Technology

Precision Industry Partners





Locatelli Meccanica S.r.l.
Copyright© 2025

Facts & Figures

- History 4
- Global activity 5
- Four columns frame vs. cast iron frame 6

Advantages of precision and accuracy

- General Features 8
- Lower ejector 9
- Quick change die-holder 10
- Automation 11

Lifetime advantages

- Software 14
- Tools long life 15
- High safety 16

Top industrial end customers

- References Minting Industry (2024) 18
- Top references other industries 19
- Other industries 20
- Quality components 22
- Technical features

23

Facts & Figures

History

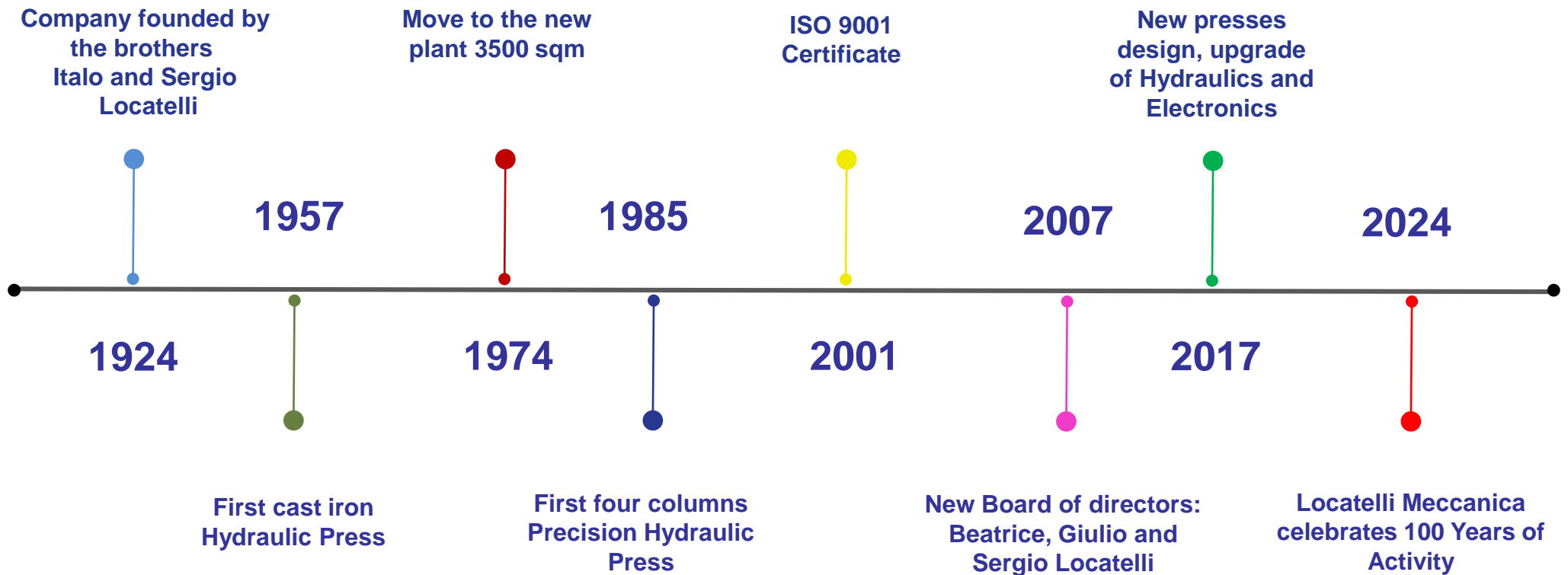

Facts & Figures

Global activity

With 100 years of experience in producing Hydraulic Pressing machines and more than two-thousand presses sold in this period, Locatelli Meccanica is a worldwide leader in the industrial markets in general and in the coins and medals sector in particular.

Locatelli Meccanica is a medium-size company which is making of its flexibility and customer care the key to its international success.

The production ranges from Industrial Presses to Minting Presses, where the extreme quality products are the result of continuous R&D, experience and enthusiasm.

The professional staff monitors and controls all the manufacturing phases, from design to production, including testing and after-sales service, assuring product quality and professional assistance.

Sales by Market (2022 – 2024)

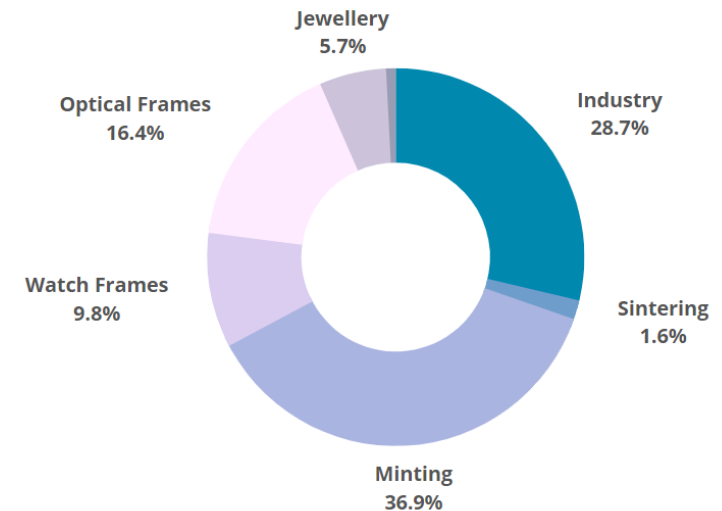

Sales by Country

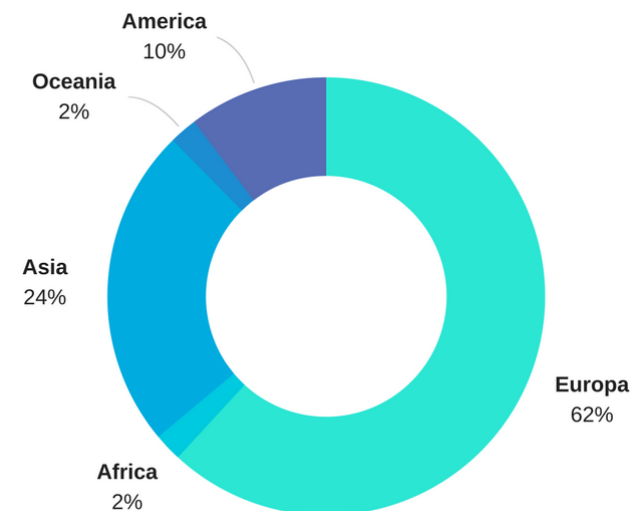

Facts & Figures

Four columns frame vs. cast iron frame

Locatelli Concept Four Columns frame

- Upper architrave made in forged C45 steel, with one-piece-punched cylinder, in order to have the material's fibers normally distributed;
- Lower architrave made in forged C45 steel;
- Four columns tightened with dynamometric wrench with 2 nuts for every column;
- Stretching of this frame is $< 2\mu\text{m}$ per Ton, 10 times less than CEE rules.

Block Stress:VM (MPa)
141,0450 [M:118475;M:277025]
133,6287
118,7900
103,3534
89,1187
74,2801
59,4434
44,6068
29,7701
14,9334
0,0968 [M:101965;M:60204]

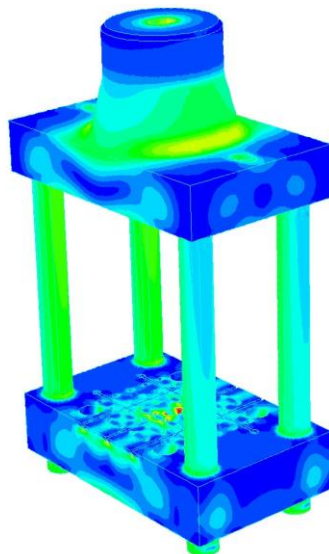

Alternative Concept Cast iron frame

- The whole frame is made with casted iron in a mould, so there are uncontrollable variables which could modify the stretching precision, such like furnace temperature, heating time, cooling temperature;
- To stabilize this frame are required additional welding operations, such like plates welded in different positions;
- The frame made in one piece, if there is a break, must be replaced completely.





Hydraulic Presses Minting Technology

Advantages of precision and accuracy

Advantages of precision and accuracy

General Features



- Down stroking four columns presses;
- Servo-control unit of the pressure;
- Production range: from 350 kN up to 12000 kN;
- Minting of coins / bars with high reliefs in Bullion / Proof-Like / Proof Quality;
- Very compact unit, electric cabinet and hydraulic pack within foot-print;
- Ergonomic design with a seating working position and wide legroom;
- Production capacity by manual feeding up to 7 parts/min in Proof-Quality;
- Possibility to integrate with an Automatic Feeding System;
- Easy maintenance in reduced dimensions.



Advantages of precision and accuracy

Lower ejector

- Lower ejector fixed into a slide for an easy maintenance;
- Allows to use the press as blanking machine, it can be easily removed;
- Free hole into the working table;
- Mechanical stop with fine tuning, for absolute ejection precision;
- Adjustable ejection power and speed.

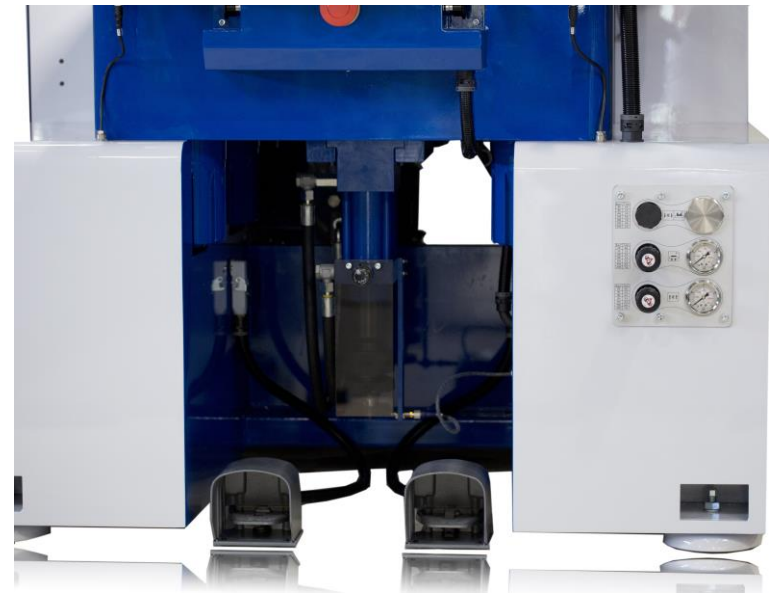

Advantages of precision and accuracy

Quick change die-holder

- **Upper Die-Holder**
- Alignment with the lower die;
- Quick die removal through fixing ring;
- Possibility to remove the die on its fixing for cleaning with minimal production's stop.
- **Lower Die-Holder**
- Quick opening: just loose two screws and remove the frontal part;
- Quick die removal through fixing ring;
- Possibility to remove the die on its fixing for cleaning with minimal production's stop;
- Pneumatic clamp for the Collar, to prevent overcharges during the working phases.

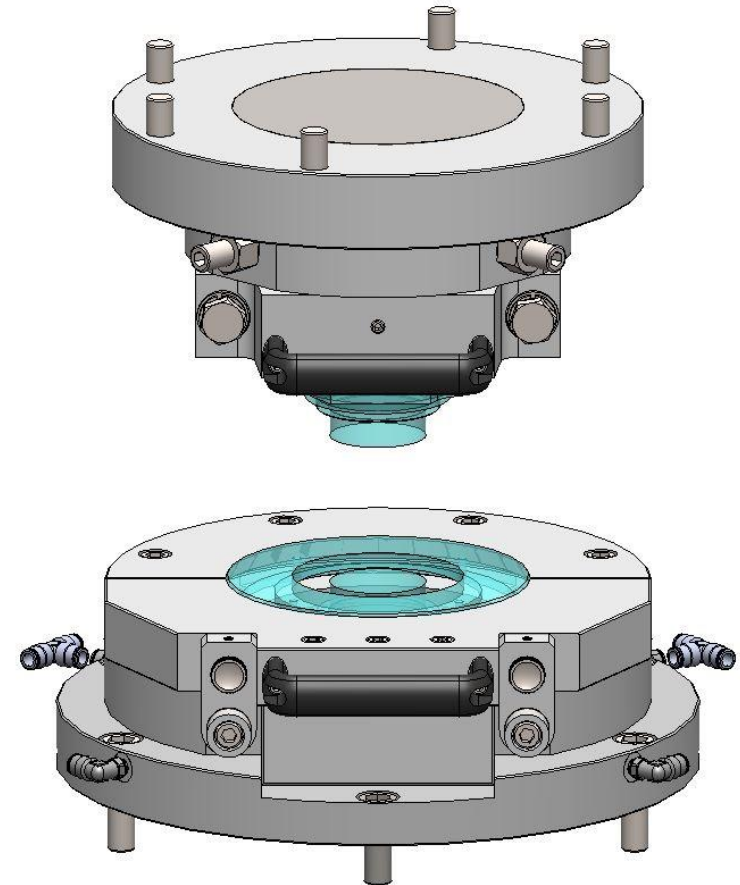

Advantages of precision and accuracy

Automation

- Our automation is the smart, compact and innovative solution designed to automate the minting and coining operations, optimizing the working cycle.

It allows to:

- Delete the man work;
- Have the stand-alone work;
- Get the advantage of the coining operation avoiding the empty time;
- Allow an industrial repeatability operation to assure a constant quality;
- The automation is adjustable to the needs and requests of the customer, depending on products size and space availability;
- Production rate: up to 12 pcs/min, depending on size and relief.

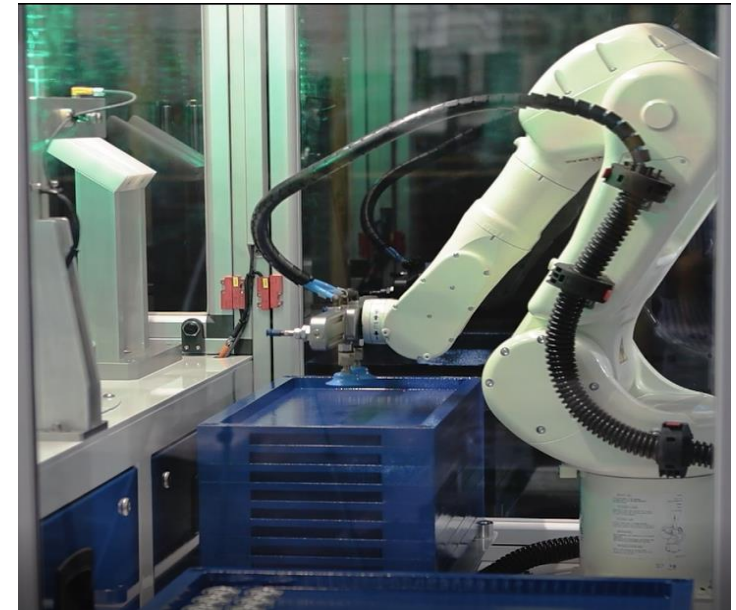

Advantages of precision and accuracy

Automation



There is a type of automation that can effectively respond to the need for Automation in this historical period, in which **Productivity** must be associated with **Flexibility** and the ability to adapt: Collaborative Robotics, a new generation of industrial robots called **Cobots**.

They can guarantee:

- Operational flexibility;
- Worker's safety;
- Rapid return on investment;
- Increase of productivity;
- Greater quality of workmanship and products;
- Improve the climate of the working environment.



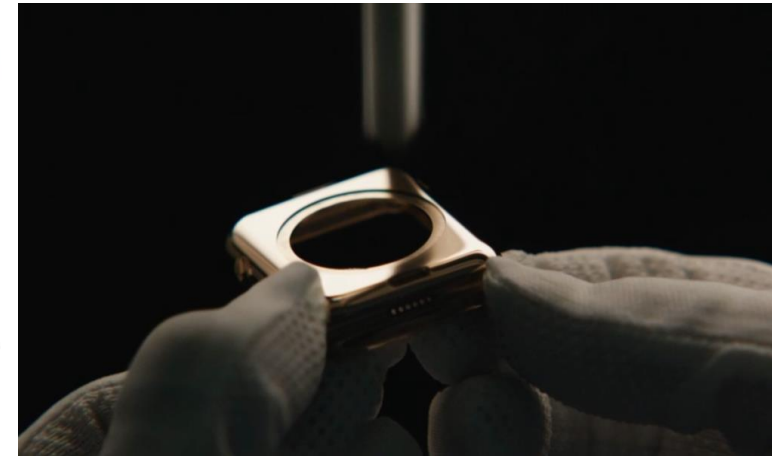
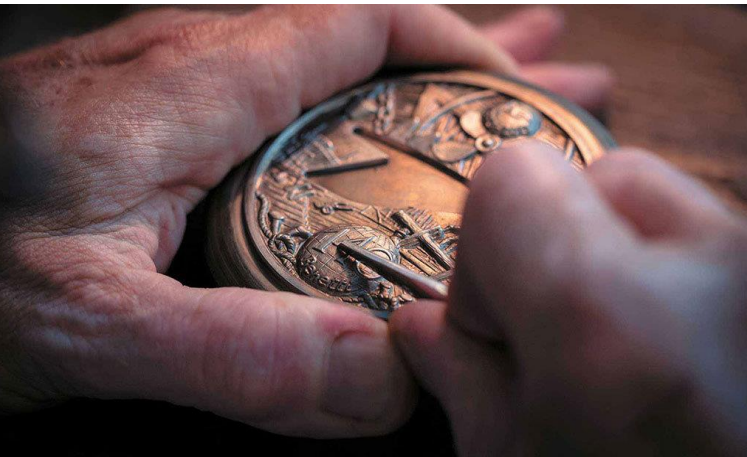

Hydraulic Presses Minting Technology

Lifetime advantages

When you buy a Locatelli Meccanica press, you're not just getting a new press. You're getting a team of people that will care for and protect your press now and into the future.

Superior Quality

Locatelli Meccanica's quality, durability, reliability and safety are legendary. To be one of the most reliable, dependable Hydraulic Press brand in the world, you can't rest on your laurels. You must be constantly testing, refining and improving.

Ownership

When you own a Locatelli Meccanica, you not only get legendary quality and reliability, but also have the backing of every Locatelli Meccanica's dealer expertise wherever you are - with genuine Service, Parts, Accessories and the most extensive and experienced dealer network.



- **Ramps of Pressure;**
- **Hologram Program;**
- **Lifting Program;**
- **Micron Program;**
- **Fast Program;**
- **Auto-Brake Program;**
- **Mould's safety Program;**
- **Medal thickness Function;**
- **Multiple pressing;**
- **Free tele-assistance;**
- **Industry 4.0 ready.**

Lifetime advantages

Tools long life

- State-of-the-art coining tools, designed and manufactured by Locatelli Meccanica partners, helps to solve the main mechanical and technological issues coming from complex designs.
- Tools protection through software: ramps of pressure, mould safety, position control. Long life guaranteed even to not-guided tools because of the perfect guided piston.
- The control of the position is routinely used for measuring the thickness of the coin by an innovative positioning device with Incremental scale with magnetic operating principle with resolution up to 0.1 μm and accuracy class up to $\pm 1 \mu\text{m}$.

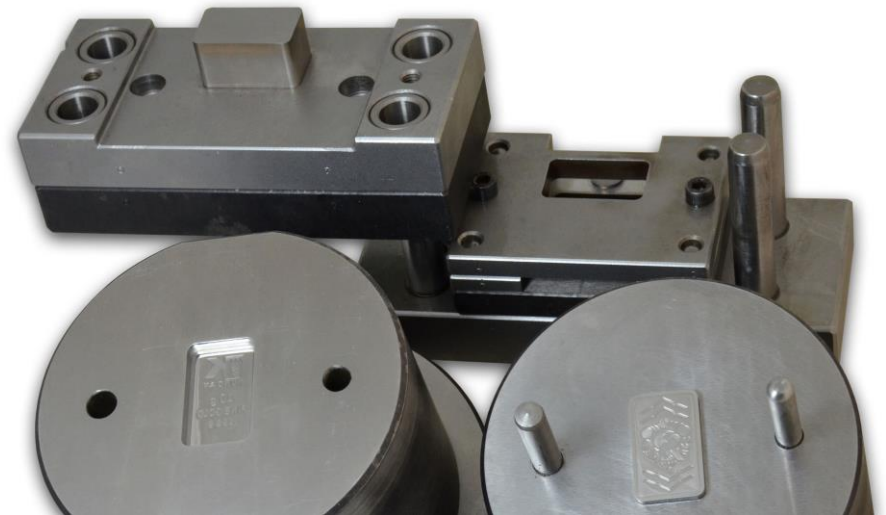

Lifetime advantages

High safety

- Updated safety devices, start/restart safety light barrier for an ergonomic working method.
- Easy access to all the components subject to maintenance.
- Easy access to the machine: the working space is completely free by each side.
- Monitored electro-valves, assembled directly on the cylinder, for the highest level of safety and a very fast repositioning.





Hydraulic Presses other applications

Top industrial end customers

Top industrial end customers

References minting industry (2024)



- Agosi Allgemeine Gold - Germany
- Argor Heraeus Sa - Switzerland
- Cooksongold Co. - United Kingdom
- Emirates Gold DMCC - Dubai
- Euromint - Germany
- Germania Mint - Poland
- Global Gold - South Africa
- Italpreziosi Srl - Italy
- L'Azurde - Saudi Arabia
- L'Azurde - Egypt
- Malta Mint - Malta
- Mint of Egypt - Egypt
- Mississauga Mint Ltd - Canada
- MKSPamp Sa - Switzerland
- MMTCPamp Pvt. Ltd - India
- Mumbai Mint - India
- Philoro M&R GmbH - Austria
- Picchiani & Barlacchi - Italy
- Pressburg Mint s.r.o - Slovakia
- Rand Refinery (Pty) Ltd - South Africa
- Romanian Mint - Romania
- Scottsdale Mint - USA
- Silver Towne Mint - USA
- Simba - Indonesia
- St. Petersburg Mint - Russia
- The Cape Mint (Pty) Ltd - South Africa
- The Tashkent Mint - Uzbekistan
- Thomas Fattorini Ltd - United Kingdom
- Unoaerre Spa - Italy
- Valcambi Sa - Switzerland

Top industrial end customers

Top references other industries

Top References worldwide

LUXOTICA[®]

Cartier

Safilo[®]
GROUP

Chopard
GENÈVE



swatch[®] 



BVLGARI

SEMIKRON
innovation + service



Top industrial end customers

Other industries



Precision industrial stamping



High quality fashion items



Composite materials industry



Micro-precise components



Hinges and other complex components

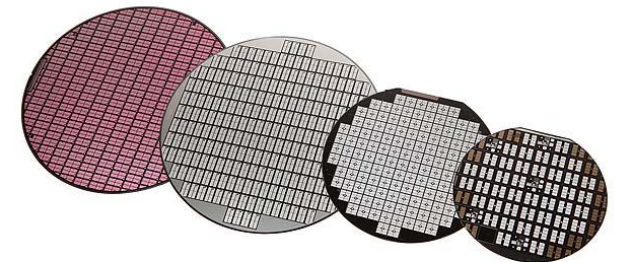

Sinter presses for electronic industry

Top industrial end customers

Other industries



Extrusion precision pipes



Calibration for forged parts



High precision industrial components



Hot stamping parts



Hot stamping / calibrated parts

Lifetime advantages

Quality components



- Electric components standard version;
- Hydraulic components standard version;
- Parts easily available in every market.
- Low wear of all components;
- Spare parts always available in our warehouse;
- Immediate telephone assistance.

Our Technological partners



Technical features



Models	T.35 4C	T.75 4C	T.125 4C	NKT.200	T.200 4C	T.300 4C	T.400 4C	T.600 4C	T.800 4C	T.1000 4C
Height mm	2350	2390	2460	2750	2640	2605	2910	3030	3320	3230
Width mm	1200	1100	1210	1470	1310	1440	1500	1700	1820	2140
Depth mm	1250	1430	1360	1450	1450	1540	1670	1670	1780	2120
Front Light mm	410	360	450	500	475	575	590	695	805	980
Side Light mm	170	310	220	380	245	305	390	325	395	630
Piston's Stroke	120	150	150	150	150	150	150	200	200	200
Daylight mm	300	390	370	390	395	410	455	550	525	609
Table Size mm	410x400	360x550	450x480	640x500	475x580	575x670	590x800	695x800	805x910	980x1290
Force T	35	75	125	190	200	300	400	600	800	1000
Motor kW	4	7,5	7,5	11	15	18,5	18,5	30	30	37
Oil Kg	220	270	330	305	325	360	420	550	610	650
Down Speed *	470	370	370	240	370	380	350	420	360	350
Load Speed *	5	7	5	3	5	4	4	4	3	3
Return Speed *	440	350	370	230	350	370	340	400	360	330
Weight Kg	1900	2400	2950	4300	4500	5500	7500	11300	15000	23500

* mm/s



locatellimeccanica.com

HEADQUARTER

Via R. Signorini, 5
52010 Subbiano (Arezzo)
Italy

Tel.: +39 0575 48305
info@locatellimeccanica.com



Follow us on social media

